

Intro

The Currentsplitter JGA2006 is a universal control unit for splitting a 4 ... 20 mA signal to 2 optical isolated 4 ... 20 mA signals and a voltage output 0 ... 5 V or 0 ... 10 V.



Liability and warranty

Every JGA2006 is checked before sending for correct operation. Therefore Boutronic has a warranty period of 1 year.

The warranty expires if:

- The defect is caused by gross negligence or by improper installation
- Repairs and/or modifications to the JGA2006 without permission from Boutronic.

Boutronic is in no way liable for damage caused as a direct or indirect consequence by the use of the JGA2006.

Manual JGA2006
December 2020
From software version 1.0a
www.boutronic.nl

Menu

- Intro 1**
- Liability and warranty 1**
- Menu..... 2**
- Connections..... 3**
 - Power supply input 3
 - Power supply output 3
 - Connection example 4
 - Internal power supply 4
 - External power supply..... 4
 - Global overview 5
 - 4 ... 20 mA input..... 5
 - Voltage output..... 5
 - Output delay 6
 - Drive time 7
 - DIP-switches..... 7
 - Calibrating with the programming button 7
 - Calibration and settings with the USB menu 8
 - Voltage output 9
 - Current output 1 9
 - Current output 2 9
 - Debug level..... 9
 - Factory defaults..... 10
 - Factory test 10
- Technical specifications..... 11**
 - General 11
 - Power 11
 - Inputs 11
 - Current input..... 11
 - Outputs 12
 - Current outputs 1 and 2 12
 - Voltage output 12
 - Measurements..... 13

Connections

In the figure below, the JGA2006 is shown schematically:

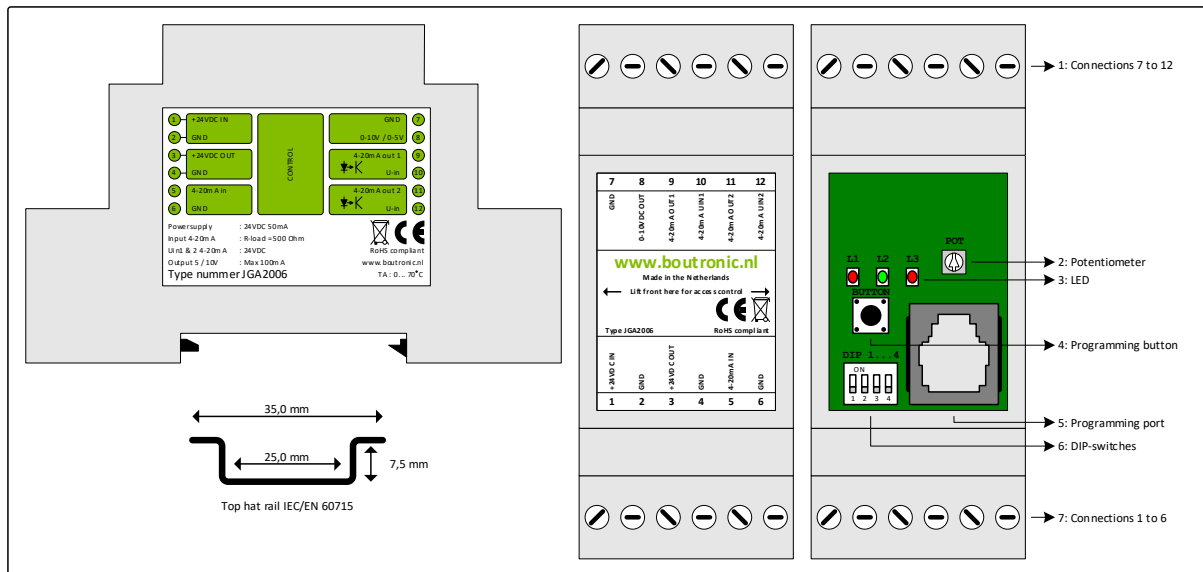

Nr	Unit	Description
1	Connection 7 ... 12	Connection 7 ... 12, see front for type of connections
2	Potentiometer	With this potentiometer you can set the total drive time for the outputs going from minimum to maximum output level (0 ... 25 sec)
3	LED's	L1: Calibrating outputs L2: When this LED is on, the analog outputs are increasing or decreasing. L3: This LED is on when the button is pressed
4	Programming button	Programming button to change program settings.
5	Firmware port	Connection to PCB (with a Boutronic dongle) for firmware update or programming settings
6	DIP-switches	DIP-switch 1: Output voltage 0 ... 5 or 0 ... 10 V DIP-switch 2: reserved DIP-switch 3: Time with potentiometer or software DIP-switch 4: Minimum and maximum calibrate levels See chapter change settings
7	Connection 1 ... 6	Connection 1 ... 6, see front for type of connections

Power supply input

The power supply for the JGA2006 is internally single-sided rectified and feeds the internal controller and the voltage output. The power supply can be 24VDC or 24VAC, taking into account that one of the 24VAC is connected to the GND and that the voltage output functions with respect to the GND.

Power supply output

The power out is the same as the power input (single-sided rectified and with capacitor buffered) and has an internal resettable fuse. This power supply can be used to power the 4... 20 mA outputs.

Connection example

Internal power supply

Below is the connection diagram using the internal power supply for powering the 4 ... 20 mA outputs. Due to this method, there is no optical separation between the JGA2006 and the external systems to which the 4 ... 20 mA is connected. The 0 ... 5 V or 0 ... 10 V has no optical isolation.

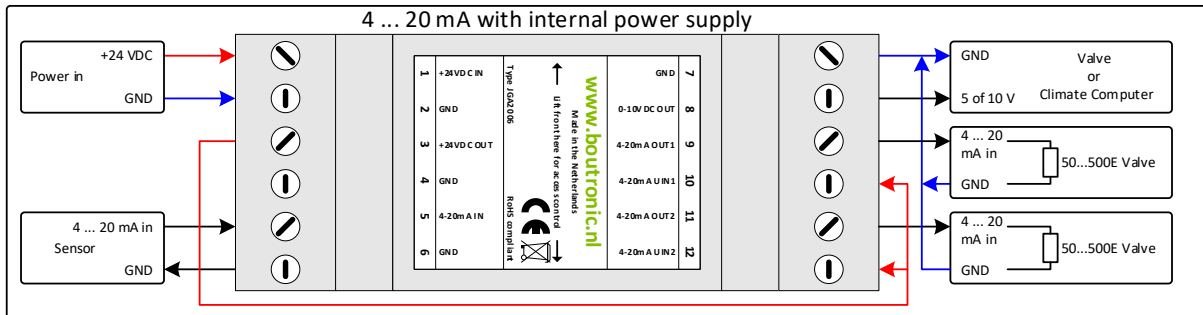

External power supply

Below is the connection diagram using an external power supply for powering the 4 ... 20 mA outputs. Due to this method, there is an optical separation between the JGA2006 and the external system to which the 4 ... 20 mA is connected. The 0 ... 5 or 0 ... 10 V has no optical isolation.

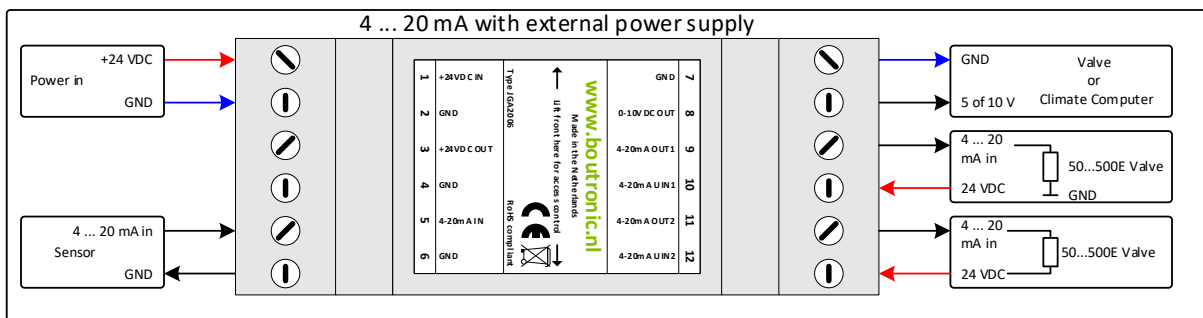

Global overview

Below is the connection diagram with a explanation overview.

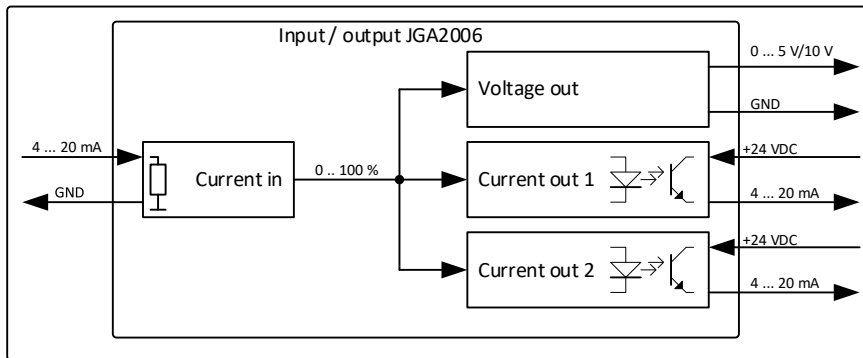

4 ... 20 mA input

A signal of 4 ... 20 mA is applied to the current input. This signal is read and converted to a 0 ... 100% value. If the current input is less than or equal to 4 mA, the JGA2006 will limit the value to 0%, if the current input is greater or equal than 20 mA, the JGA2006 will limit the value to 100%.

Note: the maximum current that may be applied to the current input is 30 mA.

Voltage output

The voltage output will control the output in response to the measured input signal.

The output voltage is scaled between 0 ... 5 V or 0 ... 10 V

DIP-switch 1 to off: the output voltage is 0 ... 5 V

DIP-switch 1 to on: the output voltage is 0 ... 10 V

Example: If the current input measures a signal of 8 mA, this is converted to a value of 25%.

The voltage output will also go to 25%. If DIP-switch 1 is set to off, the voltage output will become 1.25 V. If DIP-switch 1 is on, the output voltage will be 2.5 V.

Note: The maximum load of the voltage output is 100 mA.

Output delay

The delay with which the current outputs and voltage output run to the desired value can be determined by the potentiometer (DIP-switch 3 on off) or by software setting (DIP-switch 3 to on). The speed is defined by the time from the minimum value to the maximum value. This can be set from 0 to 25 seconds through the potentiometer or from 0 to 6000 seconds with the software settings.

Below is a schematic example for the current outputs, the same can be set for the voltage output.

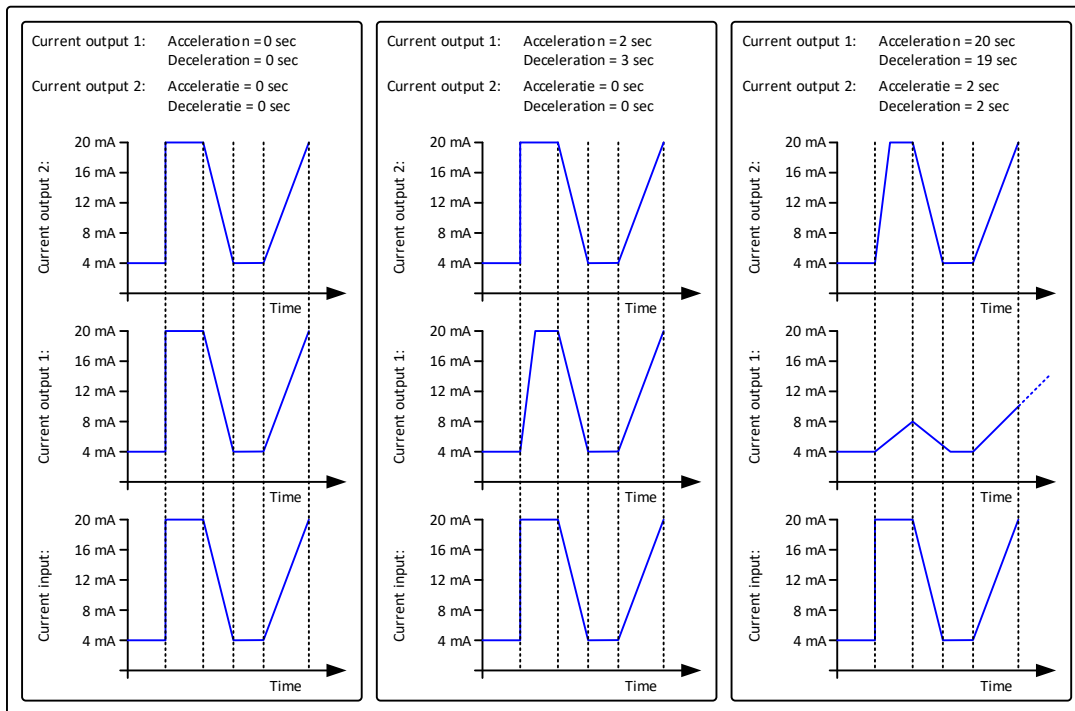

Change settings

The settings of the JGA2006 can be changed. This can be done in two ways:

With the potentiometer, the DIP-switches and the programming button or with the USB port of the PC in combination with the Boutronic USB dongle.

Drive time

You can set the total drive time of the outputs (0 ... 100%) with the potentiometer. When you turn the potentiometer CCW you set the minimum time to 0 sec, when you turn the potentiometer CW you set the maximum time to 25 sec.

(With software programming the time is between 0 and 6000 seconds)

DIP-switches

4 DIP-switches are available on the JGA2006:

	OFF	ON
DIP-switch 1	Voltage output from 0 ... 5 V	Voltage output from 0 ... 10 V
DIP-switch 2	Reserved	Reserved
DIP-switch 3	Use potentiometer form drive time	Use software setting for drive time
DIP-switch 4	Minimum and maximum calibration values are limited	Minimum and maximum calibration values are not limited

Calibrating with the programming button

The outputs can be calibrated with the programming button. The diagram below describes how this is done.

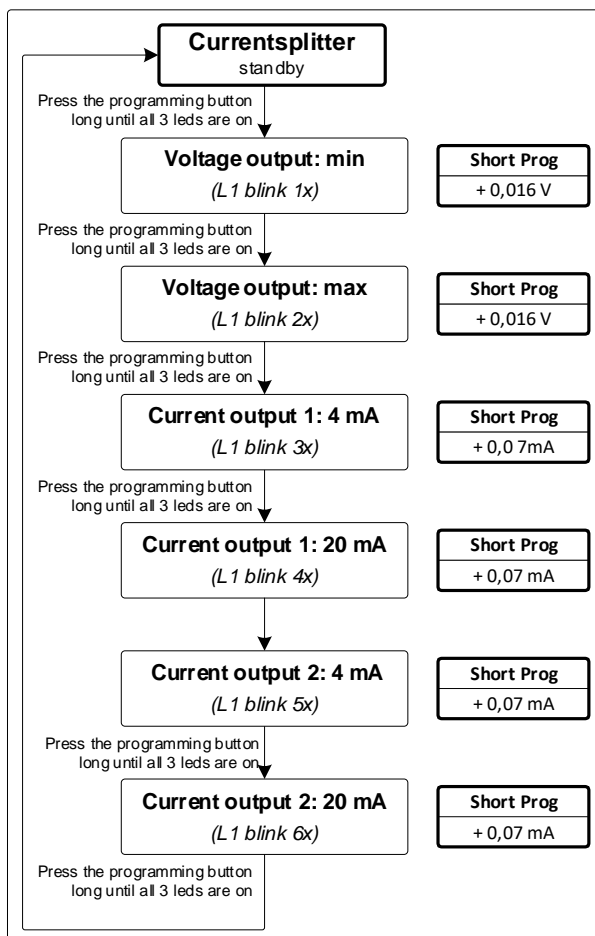

If the Programming button is pressed short the calibration value can only be increased. When the value becomes to high the value return at the lowest level.

Calibration and settings with the USB menu

You can change the settings with the USB port and the Boutronic Studio. The Boutronic Studio can be downloaded from our website:

www.boutronic.nl/producten/boutronic_studio_instellen_via_windows

To connect the JGA2006 to the PC follow the next steps:

1. Connect the JGA2006 to your PC by a Boutronic USB dongle
2. Open the Boutronic Studio 2 with the tab 'Terminal', set the baud rate to 9600 and connect
3. Click on the black screen with the mouse and press three times the + (+++)

The following text is given on the screen:

--- MENU ---

1. Voltage output
2. Current output 1
3. Current output 2
- D. Debuglevel
9. Factory defaults
- T. Factory test

With the '1, 2, 3, D, 9 and T' the option will be selected

With the '+' key the output level will be increased

With the '-' key the output level will be decreased

With the '**enter**' key the value will be stored.

With the '**esc**' key the programming will be stopped.

With the '**9**' key you will set all setting to factory levels

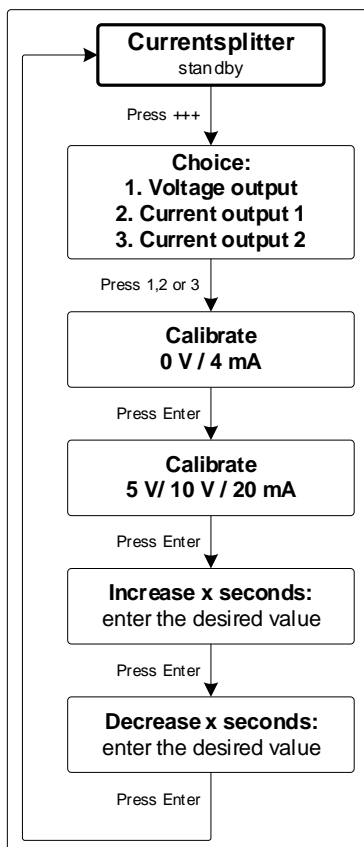

Voltage output

In this menu the calibration and the in- and decrease speed for the voltage output is set.

Value	Description	Range
U OUT 0 V ...	Calibration value for minimum voltage output	0 ... 2 V
U OUT 5 V ... or U OUT 10 V ...	Calibration value for maximum voltage output	4 ... 6 V (DIP-switch 1 off) 9 ... 11 V (DIP-switch 1 on)
Increase ... seconds	Time for voltage output to go from minimum to maximum (this time will only be used if DIP-switch 3 is on)	0 ... 6000 seconds
Decrease ... seconds	Time for voltage output to go from maximum to minimum (this time will only be used if DIP-switch 3 is on)	0 ... 6000 seconds

Current output 1

In this menu the calibration and the increase and decrease speed for the current output 1 is set.

Value	Description	Range
I OUT 4 mA ...	Calibration value for minimum current output 1	2 ... 6 mA
I OUT 20 mA ...	Calibration value for maximum current output 1	18,2 ... 20,7 mA
Increase ... seconds	Time for current output 1 to go from minimum to maximum (this time will only be used if DIP-switch 3 is on)	0 ... 6000 seconds
Decrease ... seconds	Time for current output 1 to go from maximum to minimum (this time will only be used if DIP-switch 3 is on)	0 ... 6000 seconds

Current output 2

In this menu the calibration and the increase and decrease speed for the current output 2 is set.

Value	Description	Range
I OUT 4 mA ...	Calibration value for minimum current output 2	2 ... 6 mA
I OUT 20 mA ...	Calibration value for maximum current output 2	18,2 ... 20,7 mA
Increase ... seconds	Time for current output 2 to go from minimum to maximum (this time will only be used if DIP-switch 3 is on)	0 ... 6000 seconds
Decrease ... seconds	Time for current output 2 to go from maximum to minimum (this time will only be used if DIP-switch 3 is on)	0 ... 6000 seconds

Debug level

This option is for factory use only.

Factory defaults

This option can set all programming values to factory values.

Value	Description
N. No	No values will be set to factory values
Y. Yes, without cal.	All values will be set to factory except the calibration values
A, Yes with cal.	All values and the calibration values will be set to factory

Factory test

This option is for factory test only.

Technical specifications

General

Description	Value	Unit	Remarks
Measurement	90 x 36 x 57	mm	L x B x H
Mounting	DIN-rail (Top hat rail)		IEC/EN 60715
Material	Plastic ABS		
Weight	80	gram	
Temperature storage	-20 ... +60	°C	
Temperature operational	0 ... +70	°C	
Relative humidity	10 ~ 95% RH @ 40°C, non-condensing		
Protecting range	IP20		

Power

Description	Min	Typ.	Max	Unit	Remarks
Power in	20	24	30	VDC	
	20	24	24	VAC	1
	-	35	-	mA	
Power out	20	-	30	VDC	2
	-	-	150	mA	3

- Note: one of the phases is directly connected to the GND
- This voltage is equal to the power supply in (single-sided rectified and with capacitor buffered)
- With a resettable fuse

Inputs

Current input

Description	Min	Typ.	Max	Unit	Remarks
Input voltage	-	-	30	VDC	
Input current	4	-	20	mA	Max 30 mA
Input impedance		500		Ω	

Outputs

Current outputs 1 and 2

Description	Min	Typ.	Max	Unit	Remarks
Separation	-	-	2500	V rms	Optical
Output current	4	-	20	mA	
Input voltage	20	24	30	VDC	
Resolution		0,07		mA/step	230 steps
Impedance	50	-	500	Ω	

Voltage output

Description	Min	Typ.	Max	Unit	Remarks
Output voltage	0,1	-	6,0	V	DIP-switch 1 off
	0,1	-	10,5	V	DIP-switch 1 on
Resolution	-	0,016	-	V/step	312 steps
Output current	-	-	100	mA	

Measurements

